

CO2 Fractional Laser System

The Right Laser for Every Gynecologist.

For more than 10 years, we have been at the forefront of laser gynecology research, developing revolutionary, minimally invasive gynecology treatments based on the industry's most highly effective.



SI0012

Theory

Fractional system

In general, laser resurfacing is a method of reducing wrinkles, scars and blemishes. By using a laser to remove the outer most surface of the skin, laser resurfacing offers the skin a chance to regrow into a glowing, unblemished surface. Laser resurfacing also stimulates collagen growth underneath the skin. With increased collagen, wrinkles are filled in, reducing or eliminating their appearance.

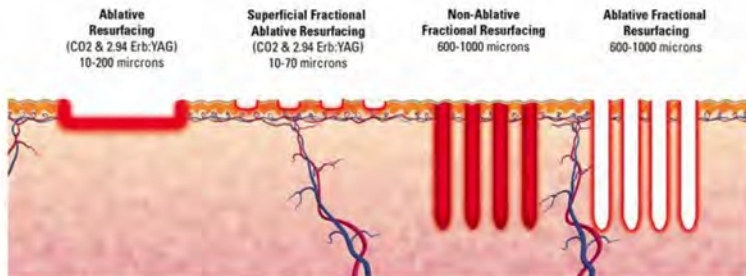

VRL system

Fractional lasers are star performers in the field of gynecology thanks to their proven ability to perform an impressive range of treatments with superior clinical results, greater patient comfort, faster healing and reduced downtime.

Configuration

- Korea Seven Joint laser Arms
360°rotation, every area and every part of body can be treated without moving machine. Adjust the articulated arm is completely enough.



Fractional CO₂ laser for facial treatment



Fractional CO₂ laser for vulva treatment

- 5 probes for different function treatment.

Fractional model reduces various scars(hypertrophic scars, depressed scars, bums, operation scars etc.) reduces seborrhetic keratosis, age pigment freckle, wrinkle, and uneven holes, skin rejuvenation.



Fractional CO₂ laser for vaginal tightening

Vaginal model
Automatically 360°rotation.
Automatically treats the vaginal sickness, easy operation with precise scale, computer control the depth and speed.

Cutting model
CO2 laser removes skin layers by vaporization. Removal age spot, sun spot by cutting. After treatment, the skin will totally be smooth than ever.



CO₂ for surgery

The world best metal RF-Driver

CO2 fractional laser device.

A high-powered, high quality, high-precision, long-life span to ensure such significant effects.

Designed and made in American COHERENT



Professional dimension structure drawing

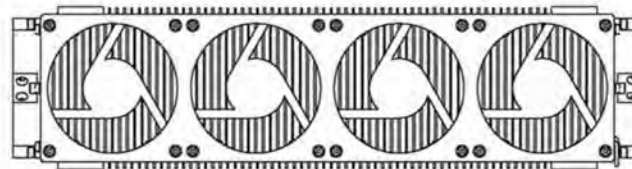
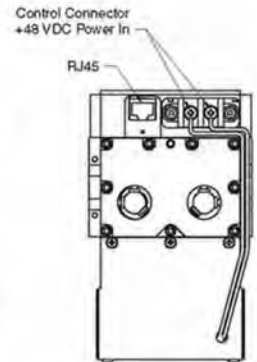
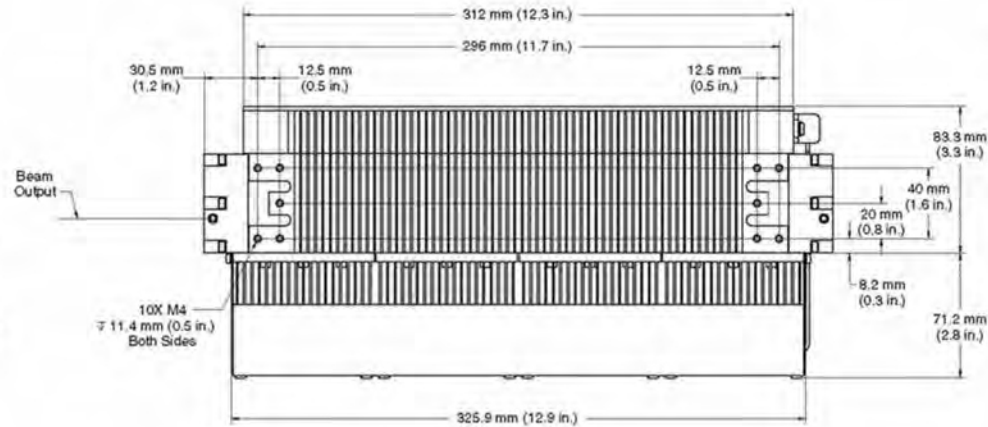
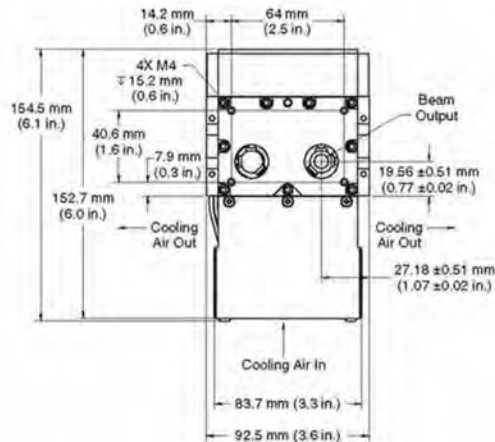
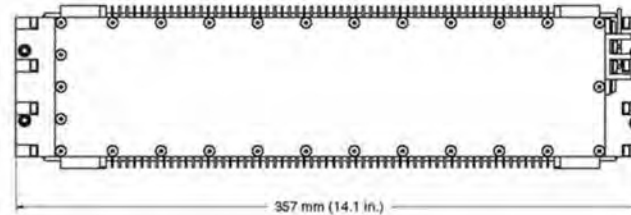

- Software design.

Including 7 treatment shape, you can choose anyone suit for your treatment.

Use triangle and linear to treat some area like nose and eyes area.



- 3 scanning model

Lowest Thermal damage when you use Random scan,

Fastest speed using Maximum distance scan,

clients will feel no pain during treatment.

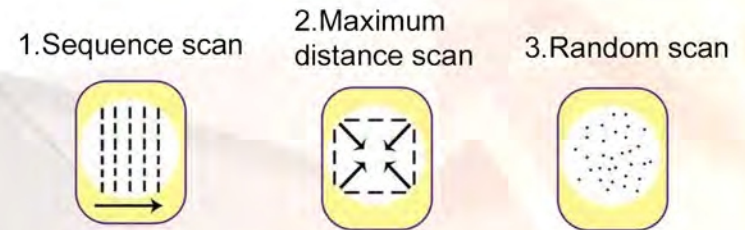

- Effective:

Tighten vagina-Fast tightening, lasting constriction, tightness to improve 60%;

Clean the vagina-Deep anti-aging, young level to improve 80%;

Moist vagina-Improving secretion, moisture level to improve 80%

Pink vagina-Vulva rejuvenation, lighten pigment and pinks labia parts, delicate degree to improve 70%.

Application

1. American FDA and German (TUV) CE approved. Machine pass the highest standard of testing. Highest quality machine in the world.

2. 40 W output power laser. More effective and powerful energy.

3. Painless. The patient only can feel warm and hot. Cannot feel any pain.

4. Fast treatment.

Each treatment less than 30 minutes and 1-3 times treatment can completely solve the vaginal problem and face problem.

5. Combination 3 system

Vaginal tightening system and Fractional CO₂ and CO₂ for surgery system.

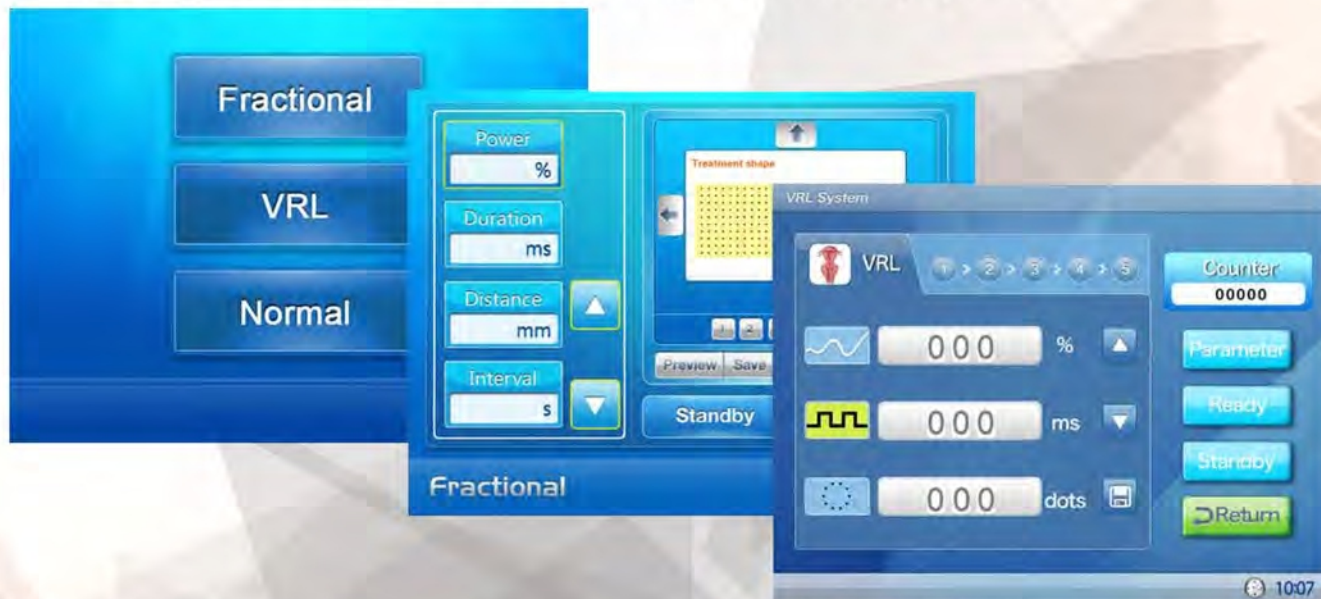

Specifications

CO2 Laser source	RF laser tube
Wavelengths	10.6um
Working mode	Pulse mode /Fractional mode/ continuous mode/Vaginal mode
Treatment heads Specification	Fractional head/Vaginal head/ vulva treatment head/Pulse treatment heads*2 (50mm/100mm) Optional(Vaginal cervical erosion head, Vaginal leakage of urine head)
Output Power	50W
Pulse Radio frequency	0.530W
Scan model	Free scan; Sequence scan; Maximum distance scan
Pulse width	0.1-10ms adjustable step forward by 0.1ms
Laser	Closed dc RF laser
Indicator light	635nm infrared
Laser origin	Korea
Cooling system	Wind
Beam transport device	7 articular optical arm.
LCD Display	10 inch 16-bit colour LCD Display
Scanning Graphics	Square, rectangle, circle, diamond, triangle, ellipse, linear
Voltage	110V-240V AC
Size	35*30*117cm
N.W	52kg
G.W	72kg & 4kg
Packing	Aluminum alloy case

Before and After

